

Data Sheet



Article number: 20331281

Description: E+G Handwheel
GN 555-100-B12-D

Measures

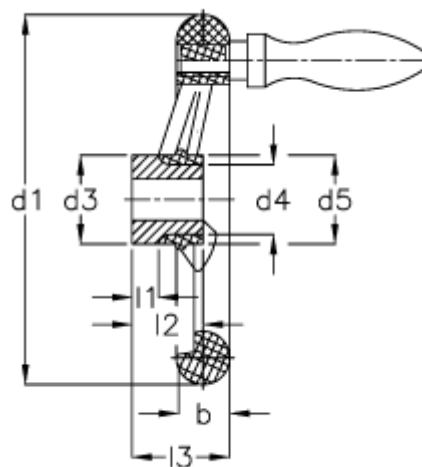
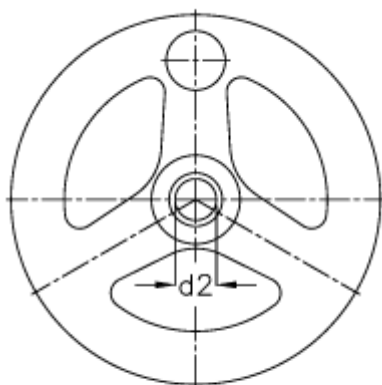

b	= 15	l1 -0.5	= -
d1	= 100	l2 -0.5	= 22
d2 H7	= 12	l3	= 26
d2 H7	= 10	Number of spokes	= 3
d3	= 24		
d4	= 18		
d5	= 28		
Handle	= 16		